



torcui
**TAKE CHARGE
OF YOUR BOLTING**

VT BATTERY TORQUE WRENCH

VT

BATTERY TORQUE WRENCH

THE WRENCH THAT CHANGED EVERYTHING

ENGINEERED TO MASTER ANY APPLICATION EFFORTLESSLY, YOUR ABILITY TO TORQUE INDUSTRIAL FASTENERS IS A SIMPLE AND QUICK CHARGE AWAY. FULLY CHARGED IN UNDER 60 MINUTES, THE VOLTA'S LITHIUM POWER WILL PROVIDE YOU WITH THE CAPABILITY TO TORQUE HUNDREDS OF FASTENINGS WITH NO HOSES OR CORDS TO LIMIT YOUR REACH. WITHIN THE VOLTA IS A DIGITAL MOTOR VECTORING SYSTEM THAT PROVIDES ACCURATE AND REPEATABLE TORQUE THROUGHOUT EACH MODEL'S FULL RANGE. THE VOLTA EXEMPLIFIES THE DURABILITY, RELIABILITY AND SAFETY THAT HAS EMBODIED EVERY INDUSTRIAL WRENCH CRAFTED BY TORCUP SINCE THE COMPANY'S FOUNDING IN 1996.



THE POWER INSIDE

1. HARDENED ALLOY STEEL FOR DURABILITY AND LONG CYCLE LIFE
2. BEARINGS SUPPORT THE LOADS EXPERIENCED AT THE SQUARE DRIVE
3. MULTI-STAGE PLANETARY GEAR SYSTEMS WITH OPTIMIZED TOOTH DESIGN
4. SMOOTH BALL BEARING ROTATION OF THE GEARBOX HOUSING INDEPENDENT FROM THE MOTOR HANDLE
5. HIGH-EFFICIENCY BRUSHLESS MOTOR
6. ERGONOMIC GLASS-FILLED NYLON HANDLE WITH A DURABLE SLIP-RESISTANT OVERMOLD
7. 18V 7.0 AH LIHD BATTERY THAT PROVIDES EXTENDED RUN-TIME
8. LCD DISPLAY FOR SETTING AND VIEWING TORQUE AND UNITS
9. SOFT-START TRIGGER
10. THRUST BEARING BETWEEN STAGES ISOLATE THE MOTOR WHEN USED IN ALL ORIENTATIONS
11. O-RINGS SEAL GREASE IN WHILE KEEPING DIRT AND WATER OUT
12. GEARS RUN ON LOW FRICTION, HIGH STRENGTH BEARING SLEEVES
13. TOOL STEEL PINS IN EACH STAGE CARRIER

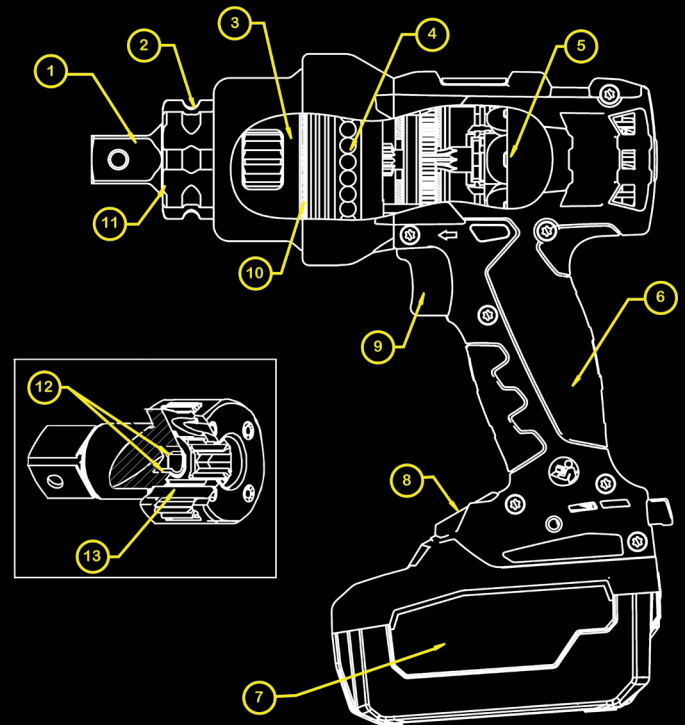



VT-500 SINGLE SPEED
TORQUE RANGE 120-500 FT/LBS
FREE SPEED 12-20 RPM

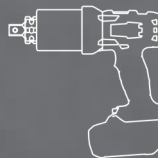

VT-1000 SINGLE SPEED
TORQUE RANGE 240-1000 FT/LBS
FREE SPEED 2-8 RPM



VT-2000 SINGLE SPEED
TORQUE RANGE 500-2000 FT/LBS
FREE SPEED 1-5 RPM



VT-3000 SINGLE SPEED
TORQUE RANGE 750-3000 FT/LBS
FREE SPEED 0.5-2 RPM

Charger Requirements: 110 - 120 V (50-60 Hz)
 and 230 - 240 V (50-60 Hz)

WWW.TORCUP.COM

POWER ENGINEERED

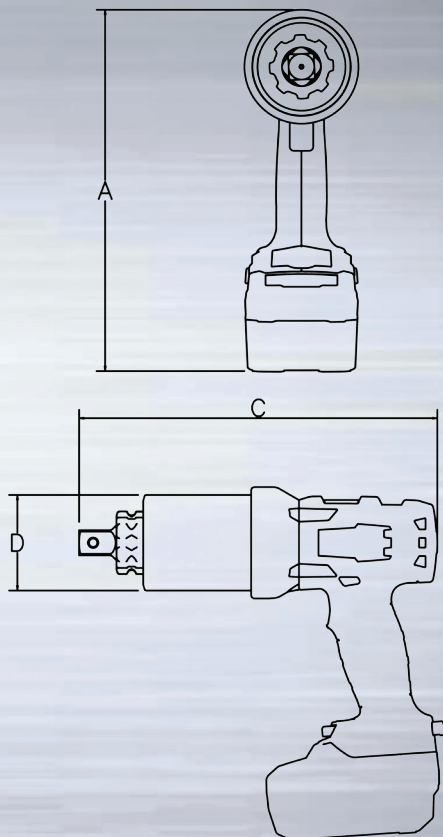

MODEL NUMBER	VT-500	VT-1000	VT-2000	VT-3000
SQUARE DRIVE	3/4"	1"	1"	1"
MIN. TORQUE (ft/lbs)	120	240	500	750
MAX TORQUE (ft/lbs)	500	1000	2000	3000
MIN. TORQUE (Nm)	160	330	680	1020
MAX TORQUE (Nm)	670	1350	2710	4030
HEIGHT A (w/ battery) (in)	10.40"	10.40"	10.40"	10.40"
HEIGHT A (w/ battery) (mm)	265	265	265	265
LENGTH C (in)	8.86"	10.97"	11.45"	13.94"
LENGTH C (mm)	225	279	291	355
DIAMETER D (in)	2.56"	2.85"	3.09"	3.75"
DIAMETER D (mm)	65	72.4	78.5	95.3
WEIGHT (w/o reaction arm & battery) (lbs)	8.3	11.5	13.1	19.6
WEIGHT (w/o reaction arm & battery) (kg)	3.8	5.2	5.9	8.9
WEIGHT (w/ reaction arm & battery) (lbs)	10.4	14.5	15.9	22.5
WEIGHT (w/ arm & battery) (kg)	4.7	6.6	7.2	10.2
RPM at Min. Torque	12	2	1	0.5
RPM at Max Torque	20	8	5	2



VT SERIES
BATTERY-POWERED
TORQUE WRENCH

PORTABLE - LITHIUM BATTERY POWER
UNIVERSAL - GLOBAL CHARGING PLATFORM
REPEATABLE - HIGH-EFFICIENCY BRUSHLESS MOTOR

SLIDING STRAIGHT
REACTION ARM



STRAIGHT
REACTION ARM



LONG EXTENDED
REACTION ARM



NOSE
EXTENSION



VOLTA CHARGER



VOLTA BATTERY



Worldwide Headquarters

1025 Conroy Place
Easton, PA 18040 USA
TOLL FREE: 1-888-TorcUP-1
TELEPHONE: 1-610-250-5800
FAX: 1-610-250-2700

www.torcup.com



TOOL
CARRYING
CASE



CHARGER
CARRYING
CASE



Catalog 2017